



Installation & Owner's Manual

FOR TECHNICAL ASSISTANCE:

CONTACT YOUR LOCAL DISTRIBUTOR

For a list of distributors, visit the Merit Industries, Inc. Web site

www.meritind.com



merit industries, inc.

PM0425-04

Table of Contents

<p>Site Preparation p. 1</p> <p>Setting up your Megatouch Game p. 1</p> <p>Game Description p. 1</p> <p style="padding-left: 20px;">CPU Section p. 1</p> <p style="padding-left: 20px;">Cash Box Section p. 2-3</p> <p>General Care and Maintenance p. 2</p> <p style="padding-left: 20px;">Screen Calibration p. 2</p> <p style="padding-left: 20px;">Monitor Color Adjustment Procedures p. 2-3</p> <p style="padding-left: 20px;">General Circuit Board Handling Information p. 3</p> <p style="padding-left: 20px;">Cleaning the Cabinet p. 3</p> <p style="padding-left: 20px;">Cleaning the Touchscreen Monitor p. 3</p> <p style="padding-left: 20px;">Cleaning the Fans and Vents p. 3</p> <p style="padding-left: 20px;">Watch Dog Timer p. 3</p> <p style="padding-left: 20px;">Linking Games p. 4</p> <p>Megatouch FORCE Software</p> <p>Game Name and Score Needed for Initial Replay p. 5</p> <p>Main Menu p. 6-7</p> <p>Credits Menu p. 8</p> <p style="padding-left: 20px;">Coin-In Menu p. 9</p> <p style="padding-left: 20px;">Coinless Coin Op Menu p. 10-11</p> <p>Games Menu p. 11</p> <p style="padding-left: 20px;">Game Setup p. 11-12</p>	<p>Hi Scores Menu p. 12</p> <p style="padding-left: 20px;">View/Clear Hi Scores p. 12</p> <p>Books Menu p. 13</p> <p style="padding-left: 20px;">Books Display p. 13</p> <p style="padding-left: 20px;">Cash Settlement p. 14</p> <p>System Menu p. 15</p> <p>Diagnostics Menu p. 16</p> <p>Presentation Menu p. 17</p> <p style="padding-left: 20px;">Operator's Presentation p. 17</p> <p style="padding-left: 20px;">Sales Person's Presentation p. 17</p> <p style="padding-left: 20px;">Operator Ad Screens p. 18</p> <p>Promotion Menu p. 18</p> <p style="padding-left: 20px;">My Merit p. 18-19</p> <p style="padding-left: 20px;">Merit Money p. 19</p> <p style="padding-left: 20px;">Promo Credits p. 19</p> <p>Megatouch FORCE Upright Hardware</p> <p>Connecting a Printer (German games only) p. 20</p> <p>Troubleshooting p. 21-23</p> <p>Parts List and Illustrations</p> <p style="padding-left: 20px;">Game Illustration p. 24-25</p> <p style="padding-left: 20px;">Replacement Parts List p. 26</p> <p style="padding-left: 20px;">Connection Diagrams p. 27-29</p> <p>Warranty and Software License Agreements</p> <p style="padding-left: 20px;">Warranty p. 30</p> <p style="padding-left: 20px;">Software License Agreement p. 31-36</p>
--	---

Site Preparation

In determining the location for your Megatouch FORCE™ video game, consideration must be given to a suitable, grounded electrical outlet. Since the game is a computerized device, it should have a separate circuit, if at all possible. If a separate circuit is not available, care should be taken to provide a clean and constant voltage. As a basic guideline, never connect the unit to a circuit that also supplies power to freezers, coolers or other high power consuming and electrical noise generating equipment. Place the game in a location where nothing will interfere with proper ventilation. The game should not be exposed to any dripping or splashing liquids. Objects filled with liquid should not be placed on the unit.

The upright model should be located on a sturdy, level surface. The game will only remain stable when the leg levellers are extended and level. Extend the leg levellers until they contact the floor and remove the weight of the game from the cabinet wheels. There are also two stabilizer rods in the back of the game to provide stability if the game is not placed against a wall (see Figure 25). Extend the threaded rods until they contact the floor. When the game is properly adjusted, it should remain stable.

Setting up your Megatouch Game

1. After removing the game from the carton, attach the power cord to the back of the game, near the on/off switch. Plug the game into a standard AC outlet.
2. Turn the power switch at the back of the game to ON and wait for it to go through its boot-up sequence. At the completion of the boot-up sequence, the game will display the Main Menu Screen.
3. The machine has been preset at the factory and therefore should not need

to be adjusted, however it is recommended that the screen be calibrated (see "Screen Calibration") and the coin or bill acceptor(s) be tested.

4. There are many custom settings available for the game. To customize the settings, follow the instructions beginning with the Main Menu section in this manual.

Game Description

The Megatouch Fusion™ comes housed in a 17" upright cabinet. This model has 3 key-locked compartments: the main bezel door, the rear door and the coin/bill door. It is equipped with a coin mech and/or bill stacker, and optional bill acceptors are also available. This model also has couplers installed in the rear of the game. These are used for future hardware upgrades which include linking and modem capabilities. Enclosed in some games along with the keys and warranty card is an Ethernet cable and a cross-over connector which can be used to link games. For linking information see "Linking Games" in the next section.

Rear Door Compartment

The rear compartment of the Fusion allows access to storage space for add-on accessories.

CPU Section

The CPU section is accessible by opening the front bezel. The CPU section houses the monitor, motherboard, I/O board, power supply, hard drive, centronics connector, and the main harness.

Located in the CPU section on the I/O board are two internal switches, SETUP and CALIBRATE. Pressing the SETUP button will bring you to the Megatouch Setup Screen. See the next section for calibration instructions.

NOTE: Additional "SET UP" and "CALIBRATE" buttons are located on the control board attached to the front bezel.

There is also a security key port on the control board, but in Fusion games, it is not operable.

Coin Mech/Bill Acceptor Cash Box

The coin mech and/or bill acceptor are accessible by opening the front bezel of the cabinet (see Figure 24 for locations). The metal cash box door is key-locked for security purposes.

General Care and Maintenance

NOTE: THIS GAME SHOULD ONLY BE SERVICED BY QUALIFIED SERVICE PERSONNEL.

CAUTION: THERE ARE HIGH VOLTAGE PARTS IN THIS GAME. BE CAREFUL WHEN SERVICING THE INSIDE OF THE GAME. GAME SHOULD ALWAYS BE UNPLUGGED BEFORE SERVICING.

Screen Calibration

NOTE: If you are using MegaWeb™ or connecting your game to TouchTunes® product, you must enable high resolution calibration in order to properly view Web pages or activate all of TouchTunes® features. All FORCE machines, except for the Classic, can support this high resolution mode. To enable high resolution:

1. Press the SETUP button inside the cabinet.
2. Touch the "System Menu" icon on the first screen that appears.
3. Touch the "Options" icon on the System Menu Screen.
4. Scroll through the options until you see "Enable Hi Resolution" and touch the box next to this option so that a check appears in the box.
5. A warning that it should not be enabled on Classic games will appear. If you have a Classic game, touch "No" to exit. If you have any other type of cabinet, touch "Yes" to continue.
6. The game will now have high resolution enabled. Touch the "X" icon in the upper corner of the screen to exit out of setup. Then continue with the following screen calibration steps.

How To Calibrate the Touchscreen:

- Find the "CALIBRATE" button located on the I/O board in the CPU section and press it to enter the screen calibration mode.
- Touch the center of the first cross that appears on the screen. Once you release your finger, a second cross will appear.

NOTE: You must hold your finger on the cross for approximately 2 seconds for the calibration to be recognized.

- Touch the center of the second cross that appears on the screen.
- Once the second cross is touched and released, another cross will appear on the screen. To test the calibration of the screen, touch the cross with your finger and slowly drag your finger around the screen. The cross should follow your movement.
- Touch the "EXIT" icon.

If you have high resolution enabled, the game will prompt you to go through the same steps again for high resolution mode.

Monitor Adjustment Procedure

For adjusting the settings on our monitors, we suggest following the procedures described below. The vertical/horizontal controls and brightness/contrast controls are located on the monitor control board, attached to the front bezel. Carefully release the cable clamp securing the board assembly to the bezel and lower the bezel so the board is accessible while viewing the monitor. Pressing the button labeled "Menu" on the monitor control board will show the on-screen display on the monitor. Adjust the monitor controls until the screens look as suggested in the following steps. When finished, replace the control board assembly securing it to the bezel with the cable clamp.

1. Set the game to the Checkerz game screen.
2. Adjust the vertical and horizontal size and vertical and horizontal position to make sure that the game screen fills the monitor screen and that the game screen is centered.
3. Adjust the brightness and contrast controls until the top sets of checkers are a rich red and the bottom set are a dark gray. The feet on the "Checkerz" character should be white. (Adjusting the brightness and contrast can also correct for a lack of sharpness.)

General Circuit Board Handling Information

Before handling any boards, observe the following procedures:

- Prevent Electro-Static Discharge by:
 1. Storing the boards in the anti-static bags in which they are shipped.
 2. Removing any static charge from your body before handling the boards.
 3. Using a ground strap when handling the boards.
- When plugging in connectors to the board, make sure the connector is inserted straight onto the header and that the connector covers all header pins.
- Do not connect any peripheral device to the board, if the power is still connected to the peripheral or if power is already applied to the board.

CAUTION: Be extremely careful when replacing the lithium battery on the motherboard. There is a danger of explosion if the battery on the motherboard is incorrectly replaced. Only replace the battery with the same type recommended by the manufacturer. Dispose of used batteries according to the manufacturer's instructions.

Cleaning the Cabinet

- The cabinet should be cleaned with a damp cloth and mild detergent. Always apply the cleaner to the cloth and not directly on the game. Liquids could enter the cabinet and damage electronics inside.

Cleaning the Touchscreen Monitor

- The touchscreen glass should be cleaned with a damp cloth and isopropyl alcohol or a *non-ammonia* cleanser. *Do not use any abrasive or vinegar-based cleansers, as they will damage the touchscreen glass.*

NOTE: DO NOT USE ANY ABRASIVE SOLVENTS, ACID OR VINEGAR-BASED CLEANSERS ON THE MONITOR OR SIDE DECALS. OVER TIME, SUCH CLEANSERS COULD HARM THE TOUCHSCREEN AND ERASE THE DECALS. BE CAREFUL NOT TO USE COMMERCIAL CLEANERS CONTAINING ANY OF THESE SUBSTANCES.

Cleaning the Fans and Vents

- The fans and vents should be cleaned of any dust on a regular basis to ensure proper ventilation of the game.
- To ensure proper operation of the game, it is important that all fans are operating correctly and that the airflow is unobstructed. Make sure nothing is placed inside the cabinet or next to the fan vents that would inhibit the flow of air. Also, if any fans are not operating, it is important that they be replaced.

Watch Dog Timer

This game has been equipped with a feature that allows it to automatically reboot if it encounters a problem. When the watch dog timer is enabled, it will reboot the machine within 2 minutes after a failure, allowing the game to automatically reset itself if a problem arises without needing a technician present. If you want to disable the watch dog timer, set DIP switch 3 on the I/O board to the open position and reboot the game.

Linking Games

Some games include an Ethernet cable and a crossover connector used to link games together. By linking your games, players can play compete against one another in real-time interactive play. Follow the instructions below to link your games. The software will allow up to 8 games to be linked.

NOTE: One Ethernet cable is required for each game you are linking. Additional Cat-5 UTP RJ45 Ethernet cables can be purchased at your local computer store.

1. Turn off and unplug the games.
2. Connect one end of the supplied Ethernet cable to the Ethernet connector on the outside of the game. The Ethernet connector is the one on the left if you are facing the back of the game. (If you are linking a Vibe or EVO, the Ethernet connector is the on the right.)
3. Connect the second Ethernet cable to the Ethernet connector on the outside of the second game.

NOTE: If you are linking games to a Combo Jukebox or a MegaTunes unit, the free ends of the Ethernet cables from the games will connect directly to the Ethernet ports on the jukebox or MegaTunes unit. If you are linking more than 2 games and a jukebox, or more than 3 games and a MegaTunes, you will need to connect an Ethernet cable to the hub connector on the jukebox or MegaTunes unit and plug the free ends of all of the cables into a hub.

MegaTunes: The Ethernet ports are located on the Ethernet hub mounted to the single board computer (SBC). The 4 ports on the right are all for Ethernet, the port on the left is for connecting a hub only. Loosen the 2 thumbnuts securing the front access panel. Connect the Ethernet cable to one of the Ethernet ports and replace the front access panel routing the cable through the slots at the bottom of the access panel.

Combo Jukebox: There are two available Ethernet couplers, labeled "Mega-Link", on the upper left if you are facing the back of the jukebox.

4. **Linking two games:** Plug the free ends of both the Ethernet cables into the crossover coupler.

Linking more than two games: Plug the free ends of the Ethernet cables into a 10 BASE-T Ethernet hub (available from your distributor as a separate part number (EC0030-01), or at your local computer store).

5. Plug in the games and turn on the power. If installation was successful, you will see a Mega-Link® button displayed on the screen after the menu appears.

NOTE: The Mega-Link® icon will appear on the game only when 2 or more games are linked.

NOTE: If a MegaTunes unit has been linked to a game, the music will be downloaded to the game. This download time will vary depending on the amount of music being downloaded.

NOTE: Megatouch games that are connected using the Mega-Link™ system must have the same level of software for proper operation. The software is designed to detect other levels of software in linked games. If a different level is detected, you will receive a screen that says, "MEGALINK MISMATCH CALL ATTENDANT." This screen will be displayed approximately 5 minutes after you turn the games on. To clear the screen and continue playing the games, you must turn the power off, unlink the games, and turn the power back on again. If you want to link these games you must upgrade all games to the same software level.

Game Name and Score Needed for Initial Replay

Solitaire, Power Solitaire, Lone Star, and Super Lone Star will always offer a replay once the listed score is attained. The other games have to reach the score listed as well as attain the high score for the game in order to offer a replay.

11 Ball	125,000	MGA Champ. Golf	No Replay
11-Up	125,000	Monster Madness	400,000
3 Blind Mice	150,000	Moon Drop	160,000
3 Some	150,000	Mystery Phrase	325,000
Air Shot	No Replay	Outer Spades	75,000
Astro Joe	120,000	Pharaoh's Fortune	45,000
Backjammin	125,000	Pharaoh's Fortune Pro Quiz Show	45,000
Battle 31	125,000	Pharaoh's 9	No Replay
Big Time Roller	60,000	Photo Hunt	400,000
Boxglide	475,000	Pile High	No Replay
Boxxi	850,000	Pix Mix	350,000
Card Bandits	200,000	Power Solitaire	55,000
Castle Bandits	200,000	Power Trivia	No Replay
Checkerz	28,000	Puck Shot	3,000
Chip Away	125,000	QB Zone	65,000
Chug 21	250,000	Q-Shot	50,000
Conquest	30,000	Quik Cell	100,000
Crazy Hearts	65,000	Quik Chess	125,000
Domino5	200,000	Quik Match	400,000
ESP Run	20	Quintzee	60,000
ESP War	125,000	Quiz Show	45,000
Euchre Nights	5,000	Rack 'em	No Replay
Fast Lane	100,000	Royal Flash	300,000
Flash 7	125,000	Run 21	250,000
Four Play	1,500,000	Snapshot	400,000
Funky Monkey	110,000	Speed Draw	125,000
Gender Bender	125,000	Strip Club	No Replay
Gin Rummy	55,000	Super Lone Star	55,000
GO-O-O-AL	No Replay	Super Snubbel	No Replay
Great Solitaire	45,000	Tai Play	240,000
H2H Gender Bender	No Replay	Take 2	110,000
H2H Photohunt	No Replay	Tennis Ace	No Replay
H2H Safari	No Replay	Tri-Castles	125,000
H2H Trivia	No Replay	Trip Flip	150,000
Hoop Jones	125	Tri-Towers	125,000
Hooter	No Replay	Trivia Treasure	No Replay
Let It Ride Trivia	125,000	Trivia Whiz	No Replay
Lone Star	45,000	Wild 8's	400,000
Lookout	400,000	Wild Apes	400,000
Magic Charms	500,000	Word Dojo	375,000
Match'Em Up	200,000	Word Safari	125,000
Mega Bowling	125	Wordserve	200,000
Megatouch Battle Command	No Replay	Wordster	100,000
Memoree	300,000	Zip 21	200,000

Main Menu

The Main Menu can be accessed by pressing the SETUP button inside the game. Use the Main Menu to set up all game software options.

NOTE: For help with the Options in any menu section, touch the green “?” icons to bring up a help screen.

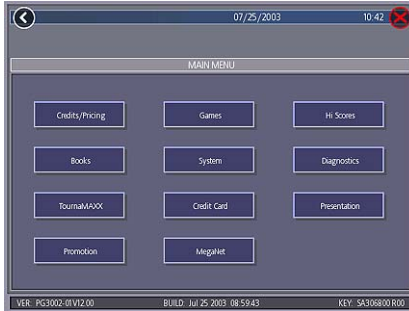

Figure 1 - Main Menu

A summary of the Main Menu functions appears in the following table. For more detail, see the corresponding sections of the manual.

Main Menu	Available Options	Information
CREDITS/ PRICING	<ul style="list-style-type: none"> • Quick Price Setup • Coin-In • Set Value of Credit • Coinless Coin Op • Options • Clear Credits • Free Credits 	The Credits Screens allow the operator to set credit rules for all games, set up the Coin-In Menu, enable the Coinless Coin Op feature, select freeplay mode, and add or clear credits.
GAMES	<ul style="list-style-type: none"> • Game Setup • Options 	In the Games Screens, you can edit the game list (choose which games are available and in what category they appear on the Category Menu) and select options for individual games.
HI SCORES	<ul style="list-style-type: none"> • View/Clear Hi Scores • Options 	Touch “CLEAR ALL GAMES” to clear all high scores or select a particular game to edit high scores for that game.
BOOKS	<ul style="list-style-type: none"> • Books Display • Cash Settlement Setup • Cash Settlement Collection 	The Books Screens display current and lifetime credits information as well as calculate and collect the location and operator fees.
SYSTEM	<ul style="list-style-type: none"> • Set Time • Security Setup • Set Game Serial Number • Volume Control • Set 6 Star PIN • Data Transfer • Options 	Set the game clock, security PIN, serial number, game volume, 6 star PIN and features, and system options such as language control, 6 Star Enable, and theft deterrent. Also use this menu to transfer books data with a USB Pen or PCMCIA flash card.

Main Menu	Available Options	Information
DIAGNOSTICS	<ul style="list-style-type: none"> • Video Test • I/O Test • Touchscreen Calibration • Touchscreen Test • View System Log • Checksum Test • System Info 	<ul style="list-style-type: none"> • Enters the Video Test to display the test screens. Touch the screen to cycle through test. • Tests the function of the I/O board, DIP switches, coin meter, lockout (if applicable), and light (EVO only). • Allows the operator to calibrate the touchscreen. Follow the instructions on the screen. • Checks touchscreen calibration. Touch the crosshairs on the screen to make sure it is accurately following your movement. • Displays operations performed by the game. • Checks the hard drive for missing or corrupted files. • Gives details about various hardware components in the game.
TOURNAMAXX	<ul style="list-style-type: none"> • Internet Setup • General Info • Connection Log • Set Update Time • Update From Server • Clear Database 	<p>Enters the TouraMAXX Set-Up Screen if the game is registered for TournaMAXX play. For more information, see the TournaMAXX installation manual.</p>
CREDIT CARD	<ul style="list-style-type: none"> • Credit Card Setup • Dial-In Setup • Credit Card Test 	<p>Enters the Credit Card Set-Up Screen if a credit card swipe is installed in your game. For more information, see the Credit Card Kit Installation Instructions.</p>
PRESENTATION	<ul style="list-style-type: none"> • Operator's Presentation • Sales Person's Presentation • Operator Ad Screens 	<p>Displays a slide show designed to be presented to location owners by the operator and another slide show to be presented to operators and distributors by the sales person. Also allows the operator to create ad screens and add custom screens created on a personal computer.</p>
PROMOTION	<ul style="list-style-type: none"> • My Merit • Merit Money • Promo Credits • Options 	<ul style="list-style-type: none"> • Enables a feature permitting players to create custom accounts. Also displays individual player data and allows the operator to back up or restore My Merit data. • Sets time periods in which location owners can use the 6 Stars feature to offer free credits to encourage game play. • Sets time periods in which the game offers a free credit while in Idle Mode. • Enables My Merit, Merit Money, and Promo Credits features.
MEGANET	<ul style="list-style-type: none"> • Entertainment Channel • Premium Erotic • Prize Zone • MegaWeb • Hot Topics • Options 	<p>Enters the MegaNet Set-Up Screen if the game is registered for TournaMAXX play. Features must be enabled for the corresponding button to appear. For more information, see the TournaMAXX installation manual.</p>

Credits/Pricing Menu

Quick Price Setup

Quick Price Setup allows the operator to make general pricing changes without entering the Games Menu.

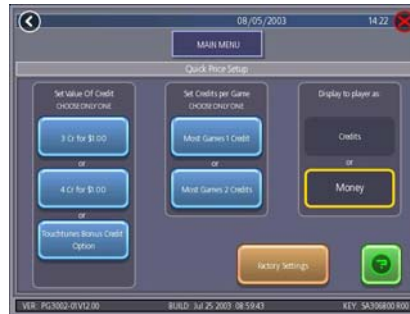

Figure 2 - Quick Price Setup Screen

3 Credits for a Dollar: Sets each game to the following price settings:

COIN INPUT	COIN VALUE	COINS	=	CREDITS	&	METER PULSES
1A	25¢	2		1		2
2B	25¢	3		2		3
3C	25¢	4		3		4

NOTE: If the game is set to 3 Credits for a Dollar, prices will be displayed in credits unless otherwise specified.

4 Credits for a Dollar: Sets each game to the following price settings:

COIN INPUT	COIN VALUE	COINS	=	CREDITS	&	METER PULSES
1A	25¢	1		1		1
2B	25¢	1		1		1
3C	25¢	1		1		1
4D	25¢	1		1		1

TouchTunes Bonus Credit Option: Sets jukebox credits to the following settings on the Megatouch Combo Jukebox or MegaTunes unit:

COIN INPUT	COIN VALUE	COINS	=	CREDITS	&	METER PULSES
1A	25¢	1		1		1
2B	25¢	2		2		2
3C	25¢	4		4		4
4D	25¢	8		10		8
5E	25¢	20		26		20

To see the TouchTunes credit settings, enter the Coin-In Menu after touching the TouchTunes Bonus Credit icon.

Most Games 1 Credit: Sets the cost of all games to 1 credit except games with a default setting of 2 credits, which will remain at 2 credits.

Most Games 2 Credits: Sets the cost of all games to 2 credits except games with a default setting of 2 credits, which are then set to 3 credits.

The operator can also use this screen to determine whether prices are displayed on-screen as credits or monetary amounts. Default values are restored with the Factory Settings icon. Touch the “?” icon for more information.

Coin-In

To Enter The “Coin-In” Screen, Touch “Coin-In” on the Credits Menu

Game cost can be controlled two ways: by changing the number of credits required to play a game or by changing the cost of a credit. The Coin-In Menu allows you to adjust the cost of a credit, as well as providing a way to give players “bonus” credits for depositing a higher amount of money.

When programming the Coin-In Menu, Channel 1 is set for the lowest value coin, Channel 2 for the next highest value, etc. If all six coin inputs are not used, the unused inputs must be set to “N/A”. Adjust the coin/credit/meter pulse settings by touching the up and down arrows on the field you want to change.

COIN INPUT	COIN VALUE	COINS	=	CREDITS	&	METER PULSES
1A	10p	3		1		3
2B	20p	3		2		6
3C	50p	1		2	player premium 25p/credit	5
4D	1£	1		5	player premium 20p/credit	10

In the above example (UK currency), each game costs one (1) credit and the cost for a single credit is 30p. This method is preferred if you want game cost to always be reflected as “1 credit.”

COIN INPUT	COIN VALUE	COINS	=	CREDITS	&	METER PULSES
1A	10p	1		1		1
2B	20p	1		2		2
3C	50p	1		6	1 bonus credit	5
4D	1£	1		15	5 bonus credits	10

In the above example (UK currency), the cost of a credit is set to 10p and each game costs 3 credits (for a total of 30p). This method allows game cost to be increased by the smallest unit of currency used (e.g. increasing the cost of Solitaire to four (4) credits would increase the game cost by 10p).

In both examples, note that meter pulses are independent of credits and only track the unit of currency (10p in the examples). Players are given an incentive to deposit more money by giving them “bonus” credits for depositing 50p or £1. Coins may be deposited in any combination of values and the game will automatically register the highest number of credits for the total amount of coins deposited. Once a game is played, any remaining fractional credits are erased.

Generally, most countries have a factory default setting. This setting can be adjusted (as described above), but will return if the game memory is cleared. Some programs, depending on the key used, have a currency default display located to the left of the coin inputs. It shows the currency value for each of the coin inputs. This display is used as a guide and is not used in any calculations. Touch the currency default display to hide/show the display.

Coinless Coin Op Menu (FORCE Games Only)

When enabled via the Options button on the Credits/Pricing Menu, the Coinless Coin Op feature allows the operator to charge on a per-game or per-time basis without players inserting money into the game. The total amount owed after gameplay is tallied by the machine and collected by the location owner. Location owners reset the game with a PIN after collection.



Figure 3 - Player Menu in Coinless Coin Op (Time and Per Game modes both enabled)

Certain features will not apply when the game is in Coinless Coin Op mode:

- MegaNet™ content is disabled.
- Merit Money and Promo Credits are not available.
- Free credits cannot be offered.
- Pricing can only be displayed in currency values, not credits.
- TouchTunes music is not available.

Settings

Touching the Settings icon allows the operator to choose whether players can play Per Game, Per Time, or both when the game is in Coinless Coin Op mode. Per Time pricing can be changed on this screen with the up and down arrows. The currency amount will apply to each 15-minute time block selected by the customer.



Figure 4 - Coinless Coin Op Menu - Settings Screen

Setting the PIN

Touch the Set PIN button on the Coinless Coin Op Menu to program the PIN. The number can be from 1 to 5 digits.

NOTE: The Coinless Coin Op PIN can also be set from the Player Menu after touching the Options button, entering the 6 Star PIN, and touching the CCO Set PIN button.

Disabling the Money Inputs

It is recommended that the money inputs be disabled when the game is in Coinless Coin Op mode. Unplug the power and signal harness connected to the bill/note acceptor and the harness connected to the coin mech (if applicable) to disable the inputs.

Per-Game Mode

When players choose this mode, a running total of the amount owed is maintained and displayed in the CREDITS box on the screen. The total is incremented after each game or function. The location owner then collects the total amount owed at the end of gameplay. If there is no activity for 10 minutes, the machine will disable and the amount owed by the player will display on screen. No further gameplay can occur until the machine is reset by a location employee using the PIN.



Figure 5 - Coinless Coin Op - Time Expired Screen

If the player leaves the game before the purchased time block has ended, the game can be reset using the PIN.

Resetting or Freezing the Game

The game can be reset at any time using the pre-programmed PIN. Once gameplay totals have been tallied by the machine, the attendant can also choose to freeze the game to prevent more activity until the transaction is complete. The Reset or Freeze buttons are accessible through the Options icon on the Player Game Menu after touching the Coinless Coin Op button. An alarm will begin to sound after 3 failed attempts to enter the valid number when entering the PIN to reset the game. The alarm will terminate when the machine is rebooted, the operator SETUP button is pressed, or the correct PIN is entered.



Figure 7 - Games Menu: Game Setup Screen

Games that were not originally enabled will be turned off and all price settings will be reset.

When you touch a category name, the next Game Setup screen shows the game positions available for that category and the price for each game, with the list at the bottom showing all games available for the selected category. In categories with Merit-thon games, players who choose Merit-thon play one round of three different games in that category for one combined score.

The Game Setup Screen also allows you to make these general changes:

Default Games: Resets the selected category menu to its default game and price settings.

Enable All Games: Turns on all games within the selected category and defaults the price settings.

Clear One: Clears a selected item from the player's game menu.

Clear All: Clears all games from the player's game menu.

To customize a particular game list, first select a category in the first Game Setup Screen. On the second screen, touch Clear All to clear the game list. Choose the menu position you want a particular game to occupy by touching that position, then touch the desired game name from the game list on the bottom of the screen. Repeat until all desired games appear in the menu (a game cannot appear in a game list more than once). Games already displayed in the menu will be red in the game list.

To adjust the price, touch the credit value next to each game. Each touch will rotate the price from 25¢ (1CR), to 50¢ (2CR), to 75¢ (3CR), to \$1 (4CR), to \$1.25 (5CR), to \$1.50 (6CR), to \$1.75 (7CR), to \$2 (8CR), and back to 25¢ (1CR).

Hi Scores Menu

View/Clear Hi Scores

Use this menu to manage hi scores. The first screen allows you to select a particular game to edit or clear all scores for all games.

To Enter This Screen, Touch “View/Clear Hi Scores” on the Hi Scores Menu and Choose a Game Name

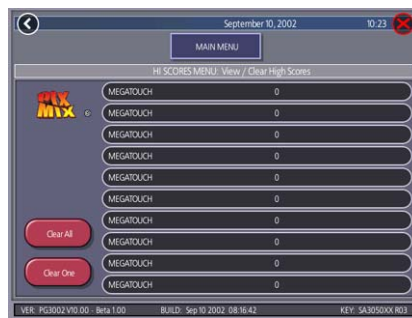

Figure 8 - Hi Scores Menu: View/Clear Hi Scores Screen

Touch “Clear All” to remove all hi scores or “Clear One” to remove a particular score after selecting it from the list.

Cash Settlement Setup

The Cash Settlement Screens are used to calculate the percentage of earnings the operator and location will receive, as well as fees collected by the operator. This will help to offset MegaNet™ operation costs.

The fee amounts can be changed on screen by touching the amount itself and using the keypad to enter a dollar figure. The other two columns display the cumulative totals for each fee and the totals for the current collection period. Fees are calculated on a prorated, per-day basis. Touch the NEXT icon to display more groups of fees. For the totals displayed on the Cash Settlement Collection Screen, choose YES or NO to display the operator's cut and enter the percentage of revenue the location will receive. Touch FINISH to save your changes.

To Enter This Screen, Touch “Cash Settlement Setup” on the Books Menu and touch “NEXT” after reading the information on the first screen



Figure 11 - Books Menu: Cash Settlement Setup Screen

NOTE: Make sure the time and date are set on the game in order to ensure correct fee calculation.

Cash Settlement Collection

The Cash Settlement Collection Screens will display the balance (total revenue minus total fees) to be split between the operator and the location.

To Enter This Screen, Touch “Cash Settlement Collection” on the Books Menu

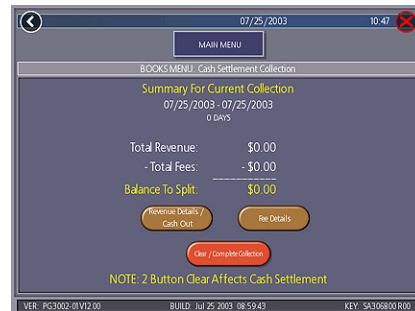

Figure 12 - Books Menu: Cash Settlement Collection

Touch “Revenue Details/Cash Out” or “Fee Details” for breakdowns and “Complete Collection” to finish. Cash Settlement totals will reset once collection is complete.



Figure 13 - Books Menu: Cash Settlement Collection: Fee Details

System Menu

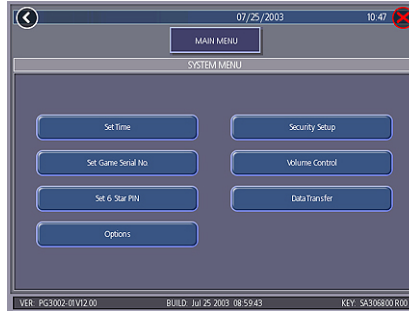

Figure 14 - System Menu

Set Time	The Set Time Menu allows you to set both the time and date on the game. Time is shown in 24-hour, "military" time (e.g. 5:00pm = 17:00). Use the up and down arrows to set the time and date.
Security Setup	The operator can set the PIN number and select which of the features (Coin-In Menu, Free Credits, Game Menu, Hi Scores, Books, All Options, and Set 6 Star PIN) will be protected by the PIN. To change the PIN, you must first enter the existing PIN (the default PIN is "0000"), then enter a new 4-digit number and touch "SET" on the keypad. The game will prompt you to re-enter your PIN to confirm. After confirming your PIN, touch the icon for each of the features you wish to protect with the PIN.
Set Game Serial Number	Use this screen to enter the game's serial number using the keypad.
Volume Control	Touch the volume control icon to adjust the volume up or down. This screen allows you to sample the sound volume without exiting the screen. The on-screen volume control can also be accessed using 6 Stars.
Set 6 Star PIN (only appears if PIN is enabled)	Brings up the Set 6 Star PIN screen via the Options button in the main game menu screen. Set the 6 Star PIN (between one and six digits) using this screen. You can enable this feature and choose which options will be accessible by 6 Stars using the System Menu: Options Screen. Touch an option box under System Menu: Options for on-screen help.
Data Transfer	Transfer information (Books data, ad screens) using a USB Pen (FORCE games only) or PCMCIA card (in MAXX games with PCMCIA card slots). Insert PCMCIA cards before powering up the game.
Options	For help with the Options in any menu section, touch the option box to bring up a help screen.

Diagnostics Menu

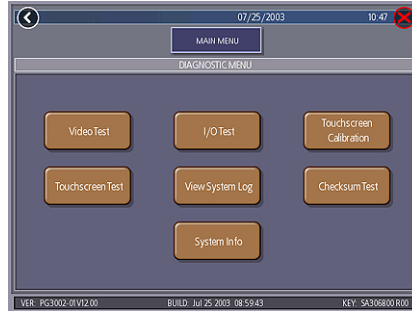

Figure 15 - Diagnostics Menu

Video Test	Touch the screen to cycle through a series of video test screens.
I/O Test	Tests the SETUP and CALIBRATE buttons, all coin channels, the coin meter, and the coin lockout feature (if applicable). A green light next to the appropriate button will register each time that item is tested, and the number next to the item should increment by one with each test. The I/O Test Screen also displays which DIP switches are on or off.
Touchscreen Calibration	Follow the on-screen instructions to calibrate the touchscreen.
Touchscreen Test	Allows you to check the touchscreen calibration accuracy. The crosshairs should follow your finger exactly when you move it across the screen.
View System Log	Displays a log of all operations performed by the game since the log was last cleared. This information is helpful for customer service in troubleshooting your game.
Checksum Test	Checks the hard drive for missing or corrupted files. With STOP ON ERROR? set to YES, a message indicating which file is corrupted will be shown whenever the game encounters an error. With STOP ON ERROR? set to NO, a list of corrupted files will be displayed when the test is complete. If errors are detected, the software on the drive may need to be reloaded. If this does not solve the problem, the drive may require replacement. The test could take up to 30 minutes.
System Info	Gives details about the following: <ul style="list-style-type: none"> • processor type and speed • motherboard manufacturer • amount of memory • Ethernet card manufacturer • sound chip type • video chip type • touchscreen manufacturer • hard drive manufacturer and capacity • modem part identification number • fan speed (FORCE games only)

Presentation Menu

The Presentation Menu features a slide show for location owners and another slide show for operators and distributors. This menu also allows operators to create ad screens and add custom screens created on a personal computer.

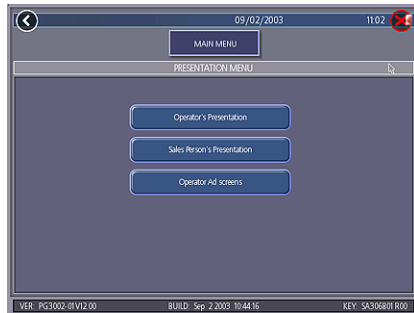

Figure 16 - Presentation Menu

Operator's Presentation

This presentation is designed to be shown to location owners by the operator. It demonstrates how to maximize earning potential with the game and increase profit with additional products.



Figure 17 - Operator's Presentation Sample Screen

Sales Person's Presentation

This presentation is designed to be shown to operators and distributors by the sales person. In addition to illustrating the revenue potential of the games, it gives details on available products and game content.



Figure 18 - Sales Person's Presentation Sample Screen

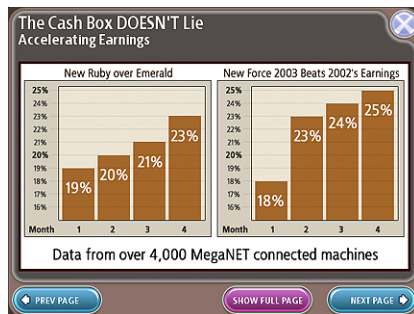

Figure 19 - Sales Person's Presentation Sample Screen



Figure 20 - Sales Person's Presentation Sample Screen

Operator Ad Screens

A total of 24 advertising screens can be created with the software and added to the game. The ads will appear along with the other attract screens when the game is in idle mode. Custom images for ad screens can also be added to the game using an appropriate storage device for your game (USB pen, CD, or PCMCIA card). Touch the green “?” icons on each screen for information on how to create ad screens and add custom screens to the machine.

In addition, a program for adding up to 120 additional ad screens can be downloaded from our Web site (www.meritind.com) in the Support/Software Downloads section.

FORCE games only: A USB Pen Kit (kit number KAV-100-008-01) is available through Merit Industries. To order, contact Customer Service at 1-800-445-9353.

Promotion Menu

The Promotion Menu is designed to encourage player interest. Use the Options button to enable each feature.



Figure 21 - Promotion Menu

My Merit (FORCE Games Only)

The My Merit feature allows individual players to create custom accounts, accessible via PIN numbers. Accounts can be created by touching the My Merit button on the Main



Figure 22 - My Merit Options

Game Menu or by accepting the option to create an account after achieving a Hi Score. Players will then have the choice to log in to their accounts through the OPTIONS button on the Player Menu and have personal data stored on the machine. Players can view their hi scores and the number of games they've played in the My Merit mode for the last year.

NOTE: My Merit data will be cleared when a software update is performed. Be sure to back up the data before updating the game.

View Player Data

Touching View Player Data will bring up a list of all players with My Merit accounts. Touching a player name will bring up the player's PIN, the total number of games played, and the date the account was created. The Show Hi Scores button will display a list of the games on which the player has the hi score and the score itself. The operator can also reward the player with free credits on the View Player Data screen if desired.

Show Game Play Frequency

This feature shows the number of games played by each My Merit player. The operator can choose whether to display all totals or just those that fall within a certain date range.

Show Player Hi Scores

Selecting a game name under this feature will bring up the Hi Scores of each My Merit player for that game, as well as the date the score was achieved. The operator can choose whether to display all Hi Scores or just those that fall within a certain date range.

Backup/Restore

My Merit data can be backed up or restored with a USB pen. After connecting a pen to the machine, touch this button to proceed with backing up or restoring all My Merit data. USB pen kits (kit number KAV-100-008-01) are available through Merit Industries. To order, contact Customer Service at 1-800-445-9353.

NOTE: Restoring My Merit data from a storage device will erase any My Merit data currently on the game.

Merit Money

The Merit Money screens allow location owners to encourage game play by offering free games (not free credits) at certain time intervals via the 6 Star feature. Select days of the week, time frames, and the number of free games (1-10 per day) to be awarded, as well as a PIN number for location owners to use in order to access Merit Money using the 6 Stars feature. Location owners can enable Merit Money by entering that specific PIN in the 6 Stars screen. One free game is given away each time the location enters the code until the predetermined daily limit is reached. Free games expire after 10 minutes, when money is deposited into the machine, or when the Merit Money time period comes to an end.

Promo Credits

The Promo Credits feature generates interest by offering operator-controlled free credits while the game is in idle mode. Select days of the week, time frames, idle time (number of minutes the game would be in idle mode before free credits are offered) and the number of credits (1-10) to be awarded. A message announcing that free credits are available will appear on the screen during idle mode when Promo Credits go into effect. Promo Credits expire after 10 minutes or when the Promo Credits time period comes to an end.

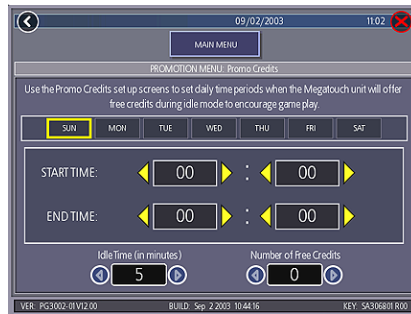

Figure 23 - Promo Credits Screen

CONNECTING A PRINTER (GERMAN GAMES ONLY)

To connect a printer to the game as needed:

1. Unlock and open the front bezel.
2. The printer port is located on the same bracket as the counter (see Figure 24).
3. When the game enters idle mode, connect the printer to the printer port on the game.

NOTE: Some printers may cause the game to reboot. Once the game has rebooted and entered idle mode, the printer will begin printing. Do not disconnect the printer until it is finished printing.

Um einen Drucker an eine Maschine anzuschliessen:

1. Die vordere Blende oeffnen.
2. Der Drucker ist in der gleichen Halterung wie der Zähler (siehe Fig. 24).
3. Wenn das Geraet in den Leerlauf uebergeht, den Drucker am Druckeranschluss des Geraets anschliessen.

BEMERKUNG: Bei bestimmten Druckern rebootet das Geraet. Nachdem das Geraet dann in den Leerlauf uebergeht, beginnt der Druckvorgang. Den Drucker bitte nicht abschalten bevor der Druckvorgang beendet ist.

Merit Industries, Inc.
Troubleshooting Guide for *Megatouch FORCE™ Games*

PROBLEM	CORRECTIVE ACTION
<ul style="list-style-type: none"> • no power • bill acceptor motor does not run • no flash on the monitor screen • no cooling fans operating • no output from power supply 	<ul style="list-style-type: none"> • Check that the power cord is connected to a "live" outlet. • Check that the power switch is on. • Check that the power cord is connected to the game power supply. • Check that the power supply's voltage select switch is set to the proper voltage. • Check the harness connections to the on/off switch and circuit breaker. • Check the circuit breaker for an "open". • Check the A/C harness connection to the power supply. • Check the line cord.
<ul style="list-style-type: none"> • no video • no cooling fan operation • screen is blank • A/C power to the monitor and bill acceptor • no output from power supply 	<ul style="list-style-type: none"> • Check the power on jumper wire located on the motherboard. It should connect J2 to pin 21 of Panel 1. If this jumper wire is missing or not connected between the correct pins, it may prevent the power supply from turning on. For more information, see Tech Note 52. • Check the D/C harness connection to the motherboard. • Check the A/C harness connection to the power supply.
<ul style="list-style-type: none"> • no video • cooling fans are working • there is a sound when coins are deposited 	<p>Radion, Classic and Upright games:</p> <ul style="list-style-type: none"> • Check the video cable connections to the motherboard and the monitor. • Check the AC power harness to the monitor. • Radion and FORCE Upright monitors will display a test pattern on the screen when the video cable is disconnected from the motherboard and the monitor has power. Disconnect the video cable and if there is no test pattern; replace the monitor chassis board. <p>EVO, Fusion, Elite and Vibe:</p> <ul style="list-style-type: none"> • Check the video cable connections to the motherboard and the LCD display (and the monitor control board in EVO and Fusion games). • Check the +12 volt supply voltage to the LCD display (yellow wire +12, black wire ground) • Check the harness connections between the PC boards on the back of the LCD display. • Replace the LCD display.
<ul style="list-style-type: none"> • no video • constant beeping or a sequence of beeps 	<ul style="list-style-type: none"> • The memory card (DIMM) may not be seated properly. Reseat the DIMM or replace it.
<ul style="list-style-type: none"> • no video • no sound when coins are deposited 	<ul style="list-style-type: none"> • Check all connections to the motherboard. • Reseat the DIMM. • Replace the motherboard or send it for repair.
<ul style="list-style-type: none"> • poor picture quality 	<ul style="list-style-type: none"> • Adjust Brightness, Contrast, Horizontal, and Vertical controls with monitor controls.
<ul style="list-style-type: none"> • coin jam 	<ul style="list-style-type: none"> • Check the coin mech and coin chute for coins blocking the pathway. • Make sure the coin harness is connected between the normally open and common terminals on the coin switch. • Disconnect the bill acceptor and the coin switch one at a time to narrow down the problem. • Check the coin harness for pinched or damaged wires. • Disconnect the coin harness from J1, J3, J7, and J8 of the I/O board. If the coin jam still appears, the I/O board will have to be sent for repair. <p><i>(NOTE: The Radion cabinets have an optical coin switch.)</i></p>
<ul style="list-style-type: none"> • meter not advancing 	<ul style="list-style-type: none"> • Check connection at I/O board. • Check wiring at J2 METER connector on I/O board.

Merit Industries, Inc.

Troubleshooting Guide for *Megatouch FORCE™ Games continued*

PROBLEM	CORRECTIVE ACTION
<ul style="list-style-type: none"> • game locks up or resets while being played or in the attract mode • no movement on the screen • power has to be cycled off and on to get the game to function again 	<ul style="list-style-type: none"> • Check the output voltages from the power supply: Enhance SFX 1211J Red wire +5 volt Yellow wire +12 volt Blue wire -12 volt White wire +5 volt power good Violet wire +5 volt VSB Black wire ground Brown wire +3.3 volt • Clean the vents and the fans of any dust and dirt that may interfere with airflow. • Clean the CPU cooling fan on the motherboard. • Replace the CPU cooling fan if it is not operating properly. • Reseat the DIMM on the motherboard. • Clear memory with the following procedure: <ul style="list-style-type: none"> • Turn off the game. • Press and hold the "Setup" and "Calibrate" buttons. • Turn the game on and keep holding the buttons until the screen displays "TWO BUTTON CLEAR DETECTED RELEASE BUTTONS". This should take about 30 seconds. • Release the buttons. This will clear high scores, clear the books and reset options, and reset the game menu and coin menu to their factory settings. • Perform a checksum test on the hard drive: <ul style="list-style-type: none"> • Turn off the game. • Turn on DIP switch 8 on the I/O board. • Turn on the game. The test will take about 10 minutes. <ul style="list-style-type: none"> • A failure will cause the test to stop. • A passed test will display "DRIVE CHECKSUM COMPLETE RESET ALL DIP SWITCHES TO REBOOT MACHINE". • With power on, turn off DIP switch 8.
<ul style="list-style-type: none"> • game locks up with "invalid key for version PG3002 – V XXXX" 	<ul style="list-style-type: none"> • Check the program number on the security key. It should be compatible with the program on the hard drive. • Check the contacts on the security key socket. Lift up on the contact on the bottom of the socket and make sure there is a good connection to the base of the security key. • Check the USB cable that connects the I/O board to the motherboard. • Check jumpers JP5 and JP6 on the I/O board. The USB cable can be connected to two connectors on the I/O board (J5A and J5B). The position of the shunts on jumpers JP5 and JP6 will enable either J5A or J5B. The shunts should be positioned towards the connector where the USB cable is connected. For more information, see Tech Note 55. • Try another security key with the same program number or test the security key in another game with the same program version.
<ul style="list-style-type: none"> • "INVALID KEY" message while downloading software to the hard drive 	<ul style="list-style-type: none"> • If the security key was replaced before the download: <ul style="list-style-type: none"> • The motherboard did not boot from the CD-ROM drive. • Check that the CD-ROM drive is set as master. • Check the ribbon cable connections between the CD-ROM drive and the motherboard. • Try another CD-ROM drive or another set of CDs.

Merit Industries, Inc.
 Troubleshooting Guide for *Megatouch FORCE™ Games continued*

PROBLEM	CORRECTIVE ACTION
<ul style="list-style-type: none"> the screen displays MAXX and not FORCE, and the H2H category is missing 	<p>When the game is turned on, it will check the type of touchscreen controller, motherboard and hard drive. If one of these does not match with FORCE hardware, the game will power up and display "MAXX" on the screen and it will not have the H2H category.</p> <ul style="list-style-type: none"> Make sure the game is only using FORCE hardware.
<ul style="list-style-type: none"> game will not download CD 	<ul style="list-style-type: none"> Make sure the CD is installed correctly, with the logo facing up. Check for scratches or a defective CD. Try a different CD-ROM drive or another set of CDs. If you're downloading a CD set, make sure each CD is of the same revision.
<ul style="list-style-type: none"> "ERROR READING DRIVE C" 	<ul style="list-style-type: none"> This message can be caused by the hard drive or in some program versions, a coin jam while the game is turned on. <ol style="list-style-type: none"> Turn the game off. Locate DS 1, position 8 and turn it on. Turn on power to the cabinet. This will start the hard drive checksum test, which should take about 20 minutes to complete. When the hard drive passes the test it will display a "CHECKSUM GOOD" message and continue to boot up into the game attract screens. This indicates a coin jam. When the hard drive fails the test, the game will lock up with a "CHECKSUM ERROR" message, which will stay on the screen until the power is turned off. In this case, the hard drive will have to be replaced.
<ul style="list-style-type: none"> "DISK BOOT FAILURE" 	<p>This message indicates the motherboard is not receiving data from the hard drive and has locked up.</p> <ul style="list-style-type: none"> Check the IDE ribbon cable connections to the motherboard and hard drive. Check the power to the hard drive. It should have +5 volts, +12 volts, and ground.
<ul style="list-style-type: none"> "QUANTUM FIREBALL, SMART FAILURE DETECTED, BACK UP HARD DRIVE" 	<p>The self-diagnostics on the hard drive has detected an error.</p> <ul style="list-style-type: none"> The hard drive will have to be replaced.
<ul style="list-style-type: none"> "CRITICAL ERROR ABORT RETRY FAIL" or "BAD COMMAND OR FILE NAME" error 	<ul style="list-style-type: none"> Try reloading the program onto the hard drive with a different set of update CD's compatible with the security key. If it will not accept the download, try another CD-ROM drive. If it still does not work, replace the hard drive.

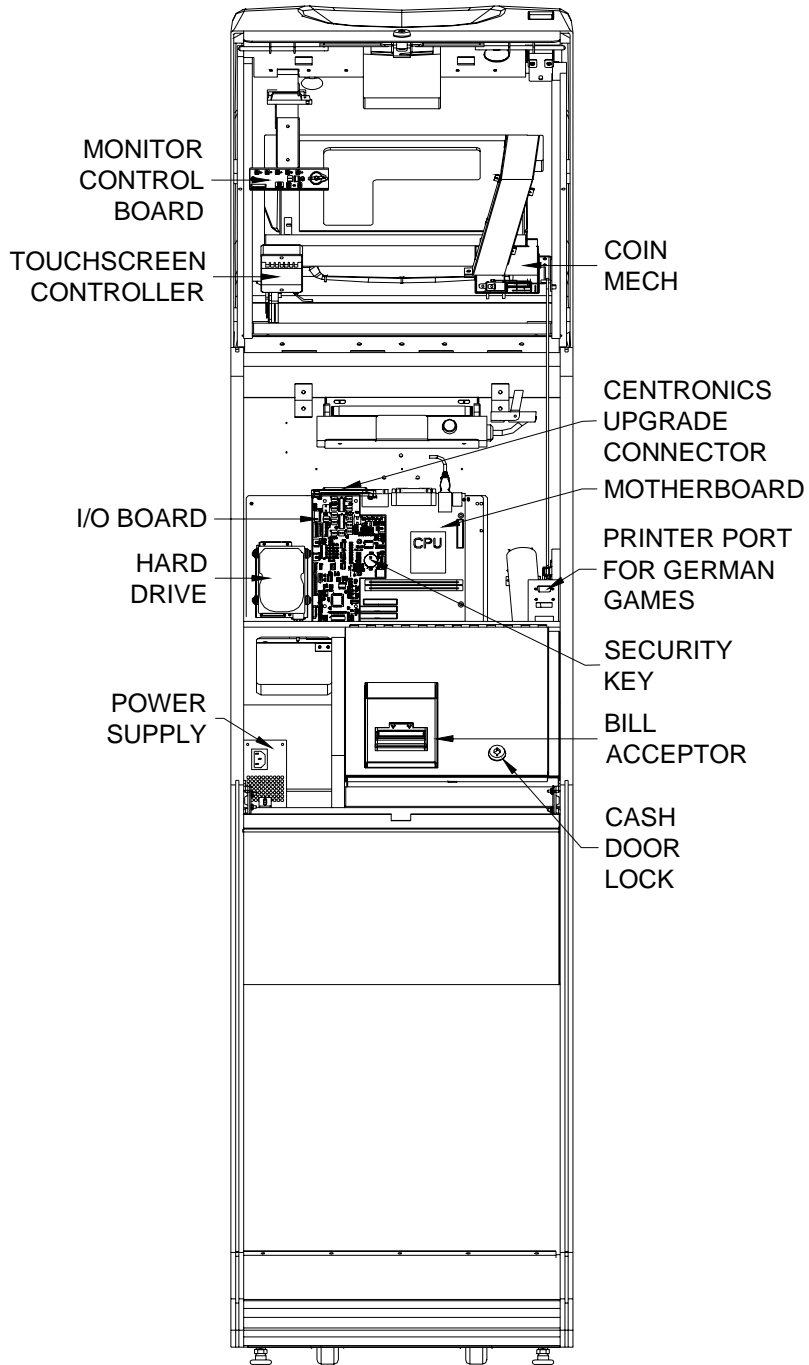

FIGURE 24 - FRONT VIEW OF THE FUSION WITH BEZEL OPEN

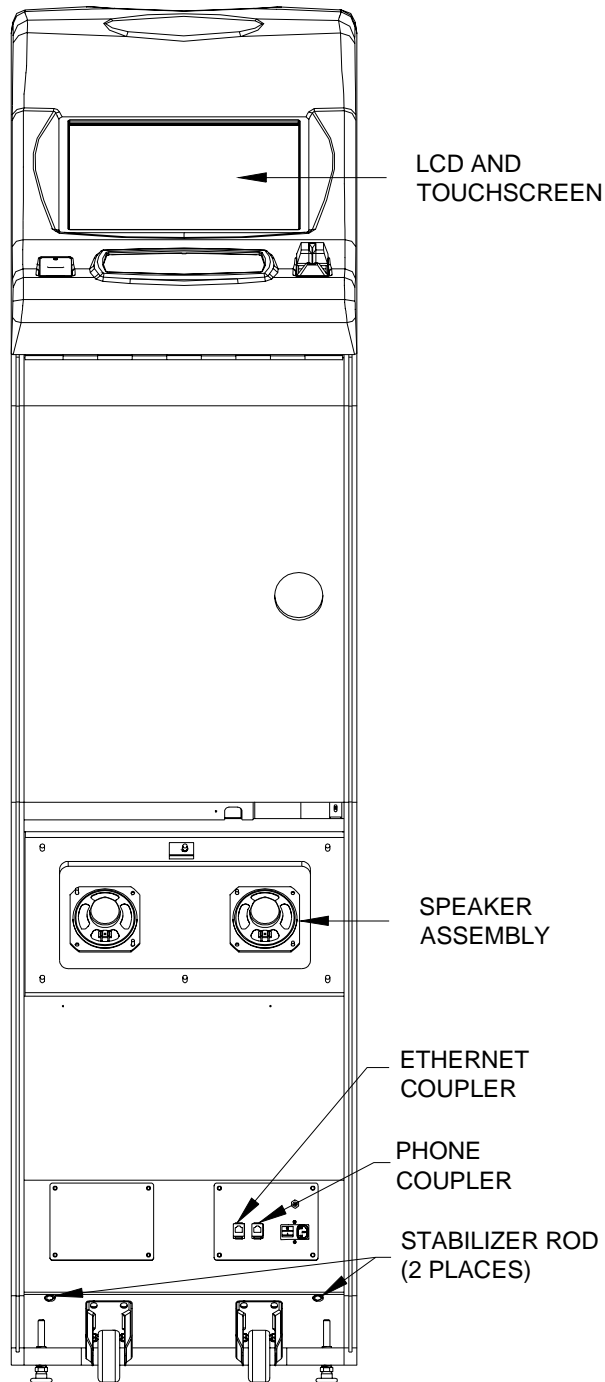

FIGURE 25 - REAR VIEW OF THE FUSION WITH BEZEL OPEN

Megatouch FORCE™ Fusion Replacement Parts List

REPLACEMENT COMPONENTS FORCE FUSION UPRIGHT (G21-111-000-XX)	
PART NUMBER	DESCRIPTION
SA10057-05	FORCE MOTHERBOARD
EC9796-06	MARS BILL ACCEPTOR. \$1/2/5, 500 STKR, AE2411
HW8159-XX	ELECTRONIC COIN MECH
EC7531-03	POWER SUPPLY, 110W ±12,+5,+3.3, AC-ON
EC9851-02	17" TOUCHSCREEN OVERLAY
EC9384-XX	17" LCD DISPLAY
EC9840-08	MICROTOUCH SMT4 TOUCHSCREEN CONTROLLER
SA10065-01	I/O BOARD
SA10066-01	CONTROL BOARD
SA3068-XX	FORCE 2004 KEY
PA3017-02	FORCE 2004.5 PROGRAM ASSEMBLY

NOTE: The parts in your game may vary. When calling for replacement parts, make sure to have your serial number available to ensure the accuracy of your order.

NOTE: In order for your Megatouch FORCE game to function properly, the hardware must only be replaced with FORCE hardware. Replacing the motherboard, I/O board, hard drive or touchscreen controller with hardware that is not specific for FORCE will eliminate some of the FORCE software features.

For additional assistance, after contacting your distributor, contact:

Merit Product Support and Services

USA and Canada call toll-free:

1-800-445-9353

Outside the USA and Canada call:

(215) 639-4700

FAX: (215) 639-5346

Merit Industries, Inc. P.O. Box 5004, Bensalem, PA 19020-8529.

You can also visit our Web site
www.meritind.com

Connection Diagrams

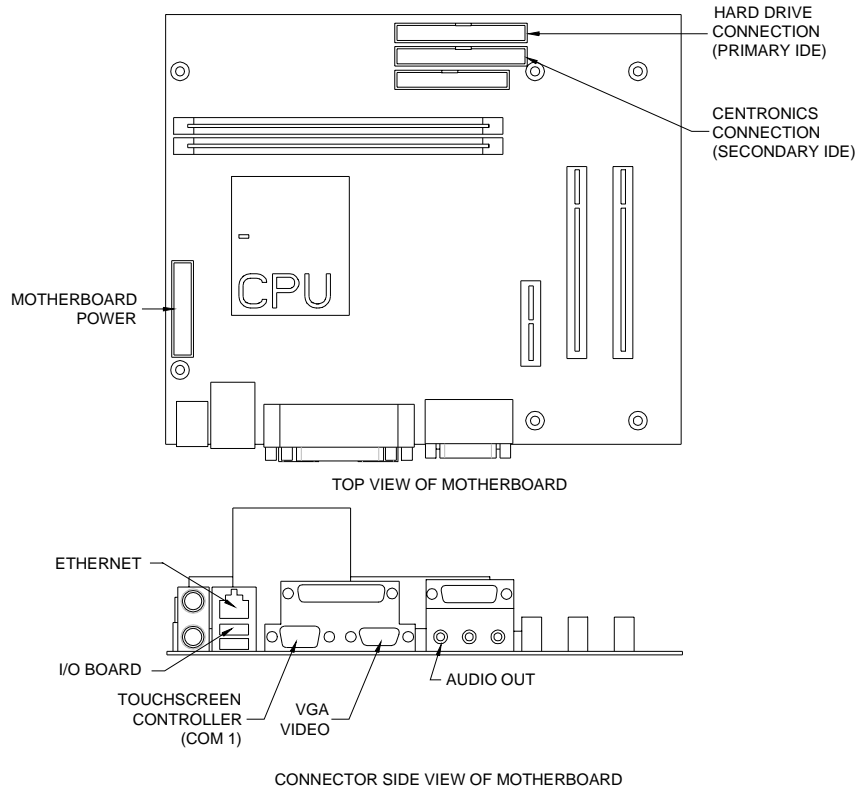

FIGURE 26 - ECS MOTHERBOARD DRAWING

Connection Diagrams

Motherboard - Power Connector

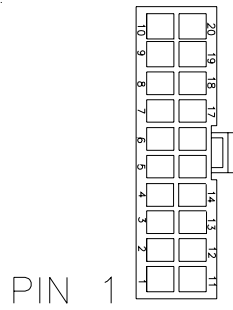

FIGURE 27 - REAR VIEW OF CABLE CONNECTOR

<u>PIN</u>	<u>WIRE COLOR</u>	<u>USE</u>
1	BROWN	+3.3 VDC
2	BROWN	+3.3 VDC
3	BLACK	GND
4	RED	+5 VDC
5	BLACK	GND
6	RED	+5 VDC
7	BLACK	GND
8	WHITE	PWR GOOD
9	VIOLET	+5V VSB
10	YELLOW	+12 VDC
11	BROWN	+3.3 VDC
12	BLUE	-12 VDC
13	BLACK	GND
14	BLACK	GND
15	BLACK	GND
16	BLACK	GND
17	BLACK	GND
18	----	----
19	RED	+5 VDC
20	RED	+5 VDC

Connection Diagrams

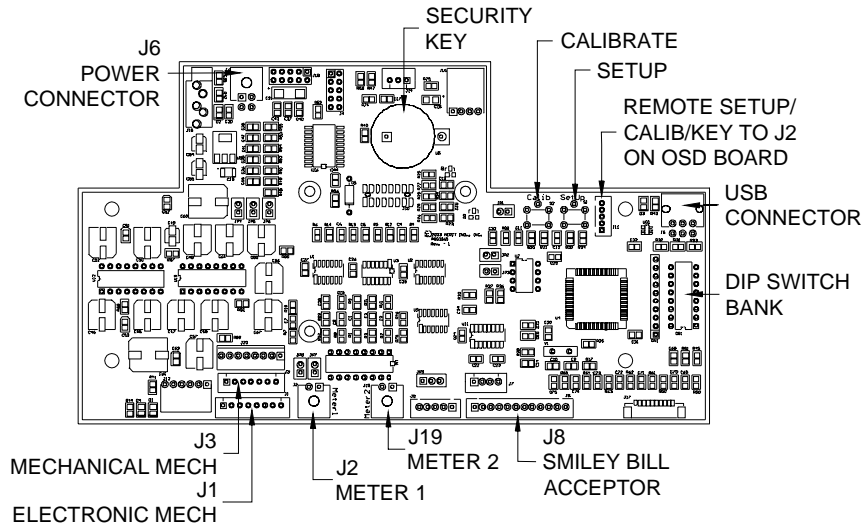

FIGURE 28 - I/O BOARD DRAWING

Merit Video Machine Limited Warranty

Merit Industries, Inc. warrants its video machines to be free from defects in material and workmanship for a period of one year from the date of purchase. The warranty covers all electrical components (except fuses and light bulbs) and printed circuit boards. The touchscreen is under warranty for a period of 3 years.

Failure due to misuse, vandalism, excessive or intentional abuse, operation outside specified conditions (including, but not limited to, improper electrical power source), fire, water damage, acts of God, acts of war and civil unrest are specifically excluded.

Merit products are carefully inspected and thoroughly tested prior to packing and shipment. Any damage discovered upon receipt of goods, whether obvious or concealed, must be reported immediately to the delivering carrier and claims made directly to them. Merit assumes no responsibility for damages once the product has left its facilities and any disputes regarding transportation damage must be resolved with the shipping company(s).

Merit will repair or replace, at its option, any component, part or assembly that fails under warranty, provided that the failed item is returned, shipping charges prepaid, to Merit's repair facility and Merit is notified of the failure within the warranty period. Merit reserves the right to request the serial numbers of the item and/or game which has failed, and copies of sales invoices, bills of lading or other documents as required to determine the validity of the warranty coverage. Merit will return or replace warranty items, as specified above, shipping charges prepaid, by ground transportation.

Merit's obligation shall be limited to repair or replacement as stated above, and shall specifically exclude any liability for consequential damages or loss of earnings.

Merit may, at its discretion, provide replacement parts under warranty prior to receiving defective items, without incurring any ongoing obligation to extend such accommodations.

In certain instances, due to geographical or other considerations, Merit may offer PCB warranty service on an extended time basis as follows:

- (a) User notifies Merit in writing (or FAX) of PCB failure, providing dates of failure, serial numbers and a brief description of failure symptoms.
- (b) Failed PCBs are accumulated for a time period or quantity accumulation, as designated by Merit and sent in one shipment to save shipping expenses.
- (c) Merit honors warranty as per dates of failure notification.

The above terms and conditions constitute the sole obligation, written or implied, of Merit Industries under its warranty coverage.

Merit Industries, Inc. Software License Agreement

Merit Industries, Inc. ("Licensor") is willing to license the enclosed software to you only if you accept all of the terms in this license agreement.

Ownership of the Software

1. The enclosed Megatouch™ software program ("Software") and the accompanying written materials are owned by Licensor and are protected by United States copyright laws, by laws of other nations, and by international treaties.

Restrictions on Use and Transfer

2. If this Software package contains multiple media types (such as CD's, flash cards, hard drives, etc), then you may use only the type of media appropriate for your Machine. You may not use the other media types on another Machine, or transfer, or assign them to another user except as part of the permanent transfer of the Software and all written materials (as provided for below in paragraph 4).
3. You may make one copy of the software for backup purpose only. You may not copy or make backup copies of any software security key or software security device under any circumstances.
4. You may permanently transfer the right to use the Software and accompanying written materials (including the most recent update and all prior versions) if you retain no copies and the transferee agrees to be bound by the terms of this Agreement. Such a transfer of this license to another party terminates your license. You may not otherwise transfer or assign the right to use the Software, except as stated in this paragraph.
5. You may not operate or allow the operation of the Software at locations where the operation of such Software does not comply with all local, state, and other governmental body laws and regulations.
6. You may not modify, adapt, translate, reverse engineer, decompile, disassemble the Software or create derivative works from the Software or any component thereof; nor may you remove, modify or hide or otherwise make unreadable or non-viewable any notice, legend, advice, watermark or other designation contained on the Software, component thereof, or output therefrom.
7. You agree that the Software and the authorship, systems, ideas, methods of operation, documentation and other information contained therein, and all versions, modifications and adaptations thereto are proprietary intellectual properties of Licensor and are protected by civil and criminal law, and by the law of copyright, trade secret, trademark and patent of the United States and other countries.

Limited Warranty

8. Licensor warrants, solely for your benefit, that the Software will function in material conformity, with its accompanying documentation for a period outlined in Licensor's standard product warranty period after your receipt of the Software.

Licensor's Obligations Under Warranty

9. Licensor's sole obligation under the aforesaid warranty shall be to utilize commercially reasonable efforts to correct or modify such portion of the Software as to make it materially conform with the applicable documentation.

Grant Of License

10. Licensor grants to you the right to use one copy of the Software on a single Megatouch™ ("Machine") accompanied by a single licensor factory authorized security key. Licensor reserves the right to update versions of the software and the content to the Machine as deemed appropriate by the Licensor.

Disclaimers

11. EXCEPT AS PROVIDED IN THE SECTION ENTITLED "LIMITED WARRANTY", LICENSOR MAKES NO OTHER PROMISES, REPRESENTATIONS OR WARRANTIES, WHETHER EXPRESSED OR IMPLIED, REGARDING OR RELATING TO THE SOFTWARE OR CONTENT THEREIN OR TO ANY OTHER MATERIAL FURNISHED OR PROVIDED TO YOU PURSUANT TO THIS AGREEMENT OR OTHERWISE AND LICENSOR SPECIFICALLY DISCLAIMS ALL IMPLIED WARRANTIES OF MERCHANTABILITY AND FITNESS FOR A PARTICULAR PURPOSE WITH RESPECT TO SAID MATERIALS OR THE USE THEREOF. TO THE MAXIMUM EXTENT ALLOWABLE BY LAW THE UNIFORM COMMERCIAL CODE OR OTHER UNIFORM LAWS SHALL NOT APPLY TO THIS AGREEMENT.

Limitation on Liability

12. IN NO EVENT SHALL LICENSOR BE LIABLE UNDER ANY CLAIM, DEMAND OR ACTION ARISING OUT OF OR RELATING TO THE SOFTWARE, OR LICENSOR'S PERFORMANCE OR LACK THEREOF UNDER THIS AGREEMENT FOR ANY SPECIAL, INDIRECT, INCIDENTAL, EXEMPLARY OR CONSEQUENTIAL DAMAGES, WHETHER OR NOT LICENSOR HAS BEEN ADVISED OF THE POSSIBILITY OF SUCH CLAIM, DEMAND OR ACTION. IN ADDITION, WITHOUT LIMITING THE FOREGOING, IN ALL EVENTS THE REMEDIES AVAILABLE TO YOU SHALL BE LIMITED TO THE AMOUNT PAID BY YOU TO LICENSOR FOR THE SOFTWARE.
13. IN NO EVENT WILL LICENSOR BE LIABLE TO YOU FOR DAMAGES, INCLUDING ANY LOSS OF PROFITS, LOST SAVINGS, OR OTHER INCIDENTAL OR CONSEQUENTIAL DAMAGES ARISING OUT OF YOUR USE OR INABILITY TO USE THE SOFTWARE.

General

14. The validity and construction of this Agreement and of the rights and obligations herein shall be determined and governed by the laws of the Commonwealth of Pennsylvania, USA. Any controversy or claim arising out of or relating to this agreement shall be resolved in the appropriate venue in Pennsylvania, USA.
15. Merit, in its sole discretion, may assign this agreement or any of its rights and obligations hereunder.
16. If you have any questions concerning this Agreement or wish to contact Licensor for any reason, please write: Merit Industries, Inc., 2525 State Road, Bensalem, PA 19020, USA.

Contrat de licence de logiciel de Merit Industries, Inc.

Merit Industries, Inc. (ci-après le "Concédant") est disposé à vous accorder la licence d'utilisation du logiciel ci-inclus, à condition que vous vous engagiez à respecter tous les termes, clauses et conditions du présent contrat de licence.

Droit de Propriété

1. Le logiciel Megatouch™ (ci-après le "logiciel") et toute la documentation écrite, restent la propriété du Concédant et sont protégés par les lois du copyright des Etats-Unis, ainsi que par les lois des autres pays et les traités internationaux.

Restriction d'Utilisation et Transfert

2. Si le présent logiciel comprend plusieurs types de composants (tels que CD-ROM, cartes flash, disques durs, etc), vous ne pouvez utiliser que ceux qui conviennent à votre appareil. Il est strictement interdit de les utiliser sur un autre appareil, les transférer -ou les céder à un autre utilisateur, sauf si en cas de transfert permanent du logiciel et de toute la documentation écrite (comme indiqué ci-dessous au paragraphe 4).
3. Il est interdit de copier le logiciel, à l'exception d'une copie de sauvegarde. Il est aussi interdit de reproduire -ou faire des copies de sauvegarde des programmes de clé de sécurité ou autres fichiers de sécurité, quelles que soient les circonstances.
4. Vous pouvez céder en permanence à un tiers -le droit d'utiliser le LOGICIEL et toute la documentation écrite l'accompagnant, (ainsi que la plus récente mise-à-jour et toutes autres anciennes versions) seulement si vous n'en gardez pas de copies, et si le cessionnaire s'engage à respecter les termes, clauses et conditions du présent Contrat. Cette cession à un tiers met fin à votre licence. Autrement, vous n'avez pas la permission de transférer ou d'accorder à un tiers le droit d'utiliser le présent logiciel, excepté que tel que décrit dans le présent paragraphe.
5. Il est interdit d'utiliser le présent logiciel ou de permettre son utilisation dans des emplacements où l'utilisation du présent logiciel n'est pas conforme aux lois et réglementations locales, nationales ou réglementations d'autres organismes gouvernementaux.
6. Il est interdit de modifier, adapter, traduire, démonter, décompiler, désassembler le logiciel ou créer du matériel dérivé du logiciel ou de tout composant de celui-ci; vous ne pouvez pas enlever, modifier ou cacher ou rendre illisible ou non-visible toute instruction, légende, information ou filigrane ou autre désignation qui apparaît dans le logiciel, composant dudit logiciel ou résultant dudit logiciel.
7. Vous convenez que le logiciel et les droits d'auteur, les systèmes, les idées, les méthodes d'utilisation, la documentation et autre information incluse, ainsi que toutes les versions, modifications et adaptations qui s'y rattachent sont les propriétés intellectuelles du Concédant et sont protégées par le droit civil et pénal et par la loi sur le copyright, le secret commercial, la marque déposée et le brevet aux Etats-Unis et dans les autres pays du monde.

Limite de Garantie

8. Le Concédant garantit seulement à votre intention, que le logiciel permettra une utilisation conforme, avec la documentation l'accompagnant, pendant la période de temps indiquée dans la période de garantie du produit standard du Concédant, à compter de la date de livraison du logiciel.

Responsabilité du Concédant aux termes de la Garantie

9. La seule obligation du Concédant aux termes de la garantie susmentionnée sera de faire tous les efforts commercialement raisonnables pour corriger ou modifier la partie du logiciel pour le rendre matériellement conforme aux spécifications de la documentation.

Concession de Licence

10. Le Concedant vous accorde le droit d'utiliser une seule copie sur un seul Megatouch™ (ci-après "Appareil") accompagné d'une seule clé de sécurité autorisée en usine et fournie par le Concedant. Le Concedant réserve le droit de mise-à-jour des versions du logiciel et du contenu de l'Appareil, quand il juge nécessaire de le faire.

Exclusion de toute autre garantie

11. EXCEPTÉ COMME PREVU DANS LA SECTION INTITULEE "LIMITE DE GARANTIE", LE CONCEDANT N'ASSURE AUCUNE AUTRE GARANTIE DE QUELQUE NATURE ET A QUELQUE TITRE QUE CE SOIT, EXPLICITE OU IMPLICITE, EN RAPPORT AVEC LE LOGICIEL ET LES COMPOSANTS QUI L'ACCOMPAGNENT OU, LE CAS ECHEANT, TOUT SUPPORT OU MATERIEL FOURNI CONFORMEMENT AU PRESENT CONTRAT. EN PARTICULIER, LE CONCEDANT NE PEUT DONNER AUCUNE GARANTIE, DE QUELQUE NATURE QUE CE SOIT, POUR LA COMMERCIALISATION DE TOUS LES PRODUITS EN RAPPORT AVEC LE LOGICIEL OU AVEC L'UTILISATION DE CELUI-CI. DANS LA MESURE OU CELA EST PERMIS PAR LA LOI, LE CODE UNIFORME COMMERCIAL OU AUTRE LOI UNIFORME NE S'APPLIQUE PAS AU PRESENT CONTRAT.

Limite de Responsabilité

12. LE CONCEDANT NE SERA EN AUCUN CAS RESPONSABLE DE TOUTE RECLAMATION, DEMANDE OU ACTION RESULTANT DE OU EN RAPPORT AVEC LE LOGICIEL OU LA PERFORMANCE OU MANQUE DE PERFORMANCE DU CONCEDANT EN VERTU DU PRESENT CONTRAT POUR TOUS DOMMAGES D'UNE NATURE QUI N'EST PAS PRESUMEE PAR LA LOI ET QUI DOIVENT ETRE EXPRESSEMENT PROUVES, DOMMAGE INDIRECTS, DOMMAGES-INTERETS POUR PREJUDICE MORAL, QUE LE CONCEDANT AIT ETE AVISE OU NON DE LA POSSIBILITE D'UNE TELLE RECLAMATION, DEMANDE OU ACTION. DE PLUS, SANS LIMITER CE QUI PRECEDE, LES DEDOMMAGEMENTS A VOTRE DISPOSITION SERONT LIMITES AU MONTANT QUE VOUS AUREZ PAYE AU CONCEDANT POUR LE LOGICIEL.
13. LE CONCEDANT NE SERA EN AUCUN CAS RESPONSABLE DES DOMMAGES, Y COMPRIS TOUTE PERTE DE PROFIT, PERTES D'ECONOMIE OU TOUS AUTRES DOMMAGES INDIRECTS OU DOMMAGES-INTERETS ACCESSOIRES DECOULANT DE L'UTILISATION OU DE L'IMPOSSIBILITE D'UTILISATION DU LOGICIEL.

Dispositions Générales

14. La validité et la construction du présent Contrat et les droits et obligations ci-inclus seront déterminés et régis par les lois du Commonwealth de Pennsylvanie aux États-Unis. Toutes litiges ou réclamations résultant ou relatives au présent Contrat feront l'objet d'une procédure de conciliation dans un établissement compétent en Pennsylvanie, aux États-Unis.
15. Merit Industries -réserve le droit de transférer le présent contrat à un tiers ainsi que ses droits et obligations ci-après.
16. Pour toutes questions concernant le présent Contrat -ou si vous désirez contacter le Concedant pour une raison quelconque, veuillez écrire à: Merit Industries, Inc., 2525 State Road, Bensalem, PA 19020, États-Unis.

Merit Industries, Inc. Softwarelizenzabkommen

Merit Industries, Inc. („Lizenzgeber“) ist nur dann bereit Ihnen eine Lizenz für die beiliegende Software zu erteilen, wenn Sie alle Bestimmungen dieses Lizenzabkommens akzeptieren.

Eigentumsvorbehalt der Software

1. Das beiliegende Megatouch™ Softwareprogramm („Software“) und die schriftlichen Unterlagen sind Eigentum des Lizenzgebers und sind durch die Gesetze der Vereinigten Staaten und anderer Länder und durch internationale Verträge urheberrechtlich geschützt.

Beschränkungen im Gebrauch und Transfer

2. Sollte diese Softwarelieferung mehrere Medien enthalten (z.B. CD, Karten, Festplatten usw.), dürfen Sie nur die für Ihre Maschine angebrachte Medienart verwenden. Die anderen Medienarten dürfen nicht auf anderen Maschinen verwendet werden oder an Dritte übergeben werden, abgesehen von einem endgültigen Transfer der Software und aller schriftlichen Unterlagen (wie im untenstehenden Paragraphen 4 beschrieben).
3. Sie dürfen nur eine Sicherungskopie der Software herstellen. Unter keinen Umständen dürfen Sie einen Softwaresicherungsschlüssel oder Sicherungsmaßnahmen kopieren oder davon Sicherungskopien herstellen.
4. Sie dürfen das Nutzungsrecht für die Software und die schriftlichen Unterlagen (einschließlich der aktuellen Version und aller vorhergehenden Versionen) an Dritte übertragen, wenn Sie keine Kopie behalten und wenn der Empfänger die Bestimmungen dieses Abkommens akzeptiert. Bei einem solchen Transfer der Lizenz an Dritte erlischt Ihre Lizenz. Abgesehen von den Bestimmungen dieses Paragraphen sind alle anderen Transfers oder Übertragungen der Nutzungsrechte für diese Software unerlaubt.
5. Sie dürfen die Software nicht benutzen oder eine Nutzung gestatten, wenn eine solche Nutzung der Software irgendwelche Gesetze und Verordnungen der kommunalen oder staatlichen Behörden verletzen würde.
6. Es ist Ihnen nicht gestattet, die Software abzuändern, zu verändern, zu übersetzen, rückumzuwandeln, zu dekompileieren oder zu zerlegen, oder aus der Software oder eines Teils davon andere Werke abzuleiten. Sie dürfen auch aus der Software, einem Bestandteil der Software oder aus den Datenausgaben der Software keine Hinweise, Bemerkungen, Ratschläge, Wasserzeichen oder andere Markierungen entfernen, verändern, verbergen oder auf andere Art unlesbar machen.
7. Sie akzeptieren, dass die Software und die Urheberschaft, die Systeme, die Ideen, die Arbeitsweisen, die Dokumentation und alle anderen darin enthaltenen Informationen und alle Versionen, Veränderungen, und Bearbeitungen davon das geistige Eigentum des Lizenzgebers sind, und dass sie durch Straf- und Zivilgesetzgebung und durch die Copyright-, Geschäftsgeheimnis-, Warenzeichen- und Patentgesetze der Vereinigten Staaten und anderer Länder geschützt sind.

Beschränkte Garantie

8. Der Lizenzgeber garantiert zu Ihren Gunsten, dass die Software für die angegebene normale Garantiezeit des Lizenzgebers nach Ihrer Annahme der Software in erheblicher Übereinstimmung mit der beiliegenden Dokumentation laufen wird.

Verpflichtung des Lizenzgebers im Rahmen der Garantie

9. Die ausschließliche Pflicht des Lizenzgebers im Rahmen der vorstehenden Garantie besteht darin, alle geschäftlich vertretbaren Schritte zu unternehmen, um Teile der Software zu berichtigen oder abzuändern, bis sie mit der beiliegenden Dokumentation erheblich übereinstimmen.

Übertragung der Lizenz

10. Der Lizenzgeber gibt Ihnen das Anrecht, eine Kopie der Software auf einer einzelnen Megatouch™ („Maschine“) mit einem einzelnen werksmäßig gestatteten Sicherheitsschlüssel zu benutzen. Der Lizenzgeber behält sich das Recht vor, nach eigenem Ermessen die Software und den Inhalt der Maschine zu verbessern.

Beschränkungen

11. ABGESEHEN VON DEN BESTIMMUNGEN DES PARAGRAPHEN „BESCHRÄNKTE GARANTIE“ GIBT DER LIZENZGEBER KEINE SONSTIGEN VERSPRECHEN, VERPFLICHTUNGEN ODER GARANTIEEN, OBERAUSDRÜCKLICH ODER STILLSCHWEIGEND, FÜR DIE SOFTWARE ODER IHRE BESTANDTEILE ODER FÜR ALLE ANDEREN MATERIALIEN, DIE IHNEN IM RAHMEN DIESES ABKOMMENS ZUR VERFÜGUNG GESTELLT ODER ÜBERLASSEN WERDEN, UND DER LIZENZGEBER LEHNT AUSDRÜCKLICH ALLE ANSPRÜCHE AUF MARKTFÄHIGKEIT UND EIGNUNG DER BESAGTEN MATERIALIEN FÜR DEN GEWÖHNLICHEN GEBRAUCH AB. SOWEIT GESETZESMÄSSIG ZUGELASSEN, SOLLEN DIE HANDELSRECHTLICHE GESETZGEBUNG AUS DEM UNIFORM COMMERCIAL CODE ODER ANDERE GESETZE AUF DIESES ABKOMMEN NICHT ANWENDBAR SEIN.

Haftungsbeschränkung

12. DER LIZENZGEBER HAT KEINERLEI HAFTUNG BEI EINEM ANSPRUCH, EINER FORDERUNG ODER EINER KLAGE, DIE AUF NUTZUNG DER SOFTWARE, DER LEISTUNG DES LIZENZGEBERS ODER DESSEN VERSAGEN IM RAHMEN DIESES ABKOMMENS FÜR JEGLICHE FOLGE-, INDIREKTE, SONDER- ODER NEBENSCHÄDEN BERUHEN, SELBST WENN DER LIZENZGEBER AUF DIE MÖGLICHKEIT EINES SOLCHEN ANSPRUCHES, EINER FORDERUNG ODER EINER KLAGE HINGEWIESEN WURDE. WEITERHIN UND OHNE BESCHRÄNKUNG DES LETZTEN SATZES, DÜRFEN IN ALLEN FÄLLEN DIE IHNEN ZUR VERFÜGUNG STEHENDEN ABHILFEN DIE VON IHNEN FÜR DIE SOFTWARE AN DEN LIZENZGEBER GEZAHLTE SUMME NICHT ÜBERSCHREITEN.
13. DER LIZENZGEBER HAT IN KEINEM FALL EINE HAFTUNG IHNEN GEGENÜBER FÜR SCHÄDEN, EINSCHLIESSLICH ETWAIGER GEWINNVERLUSTE, NICHT REALISIERTER EINSPARUNGEN ODER ANDERER NEBEN- ODER FOLGESCHÄDEN, DIE AUS IHRER VERWENDUNG ODER GEBRAUCHSUNFÄHIGKEIT DER SOFTWARE ENTSTEHEN.

Allgemein

14. Die Rechtsgültigkeit und Provisionen dieses Abkommens und der darin enthaltenen Rechte und Pflichten werden durch die Gesetze des Commonwealth of Pennsylvania bestimmt. Alle Ansprüche, die aus diesem Abkommen entspringen oder dieses Abkommen betreffen, werden am jeweiligen Verhandlungsort in Pennsylvania, USA, verhandelt.
15. Merit kann nach eigenem Ermessen dieses Abkommen oder jedes der darin enthaltenen Rechte und Pflichten an Dritte abtreten.
16. Bei Rückfragen über dieses Abkommen oder wenn Sie den Lizenzgeber aus einem anderen Grund kontaktieren wollen, bitte schreiben an: Merit Industries, Inc., 2525 State Road, Bensalem, PA 19020, USA.

Please read the enclosed license agreement. Operation of this game constitutes acceptance of the Merit Software License Agreement.

Veillez lire le contrat de licence d'utilisation ci-inclus. Si vous utilisez ce jeu, vous vous engagez à respecter les termes et conditions du contrat de licence d'utilisation du logiciel de Merit.

Bitte beiliegendes Lizenzabkommen durchlesen. Das Merit Software Lizenzabkommen tritt in Kraft, sobald dieses Spiel verwendet wird.